

Three Electrode Gas Tube Surge Arrester

Part Number: 3H-90J1

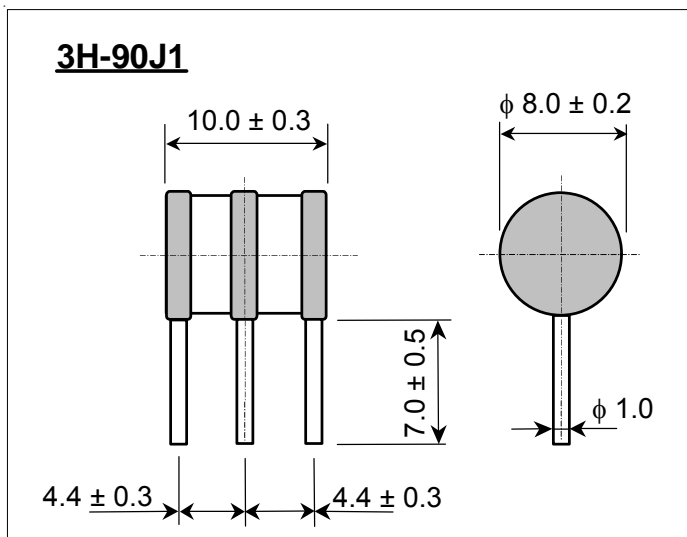

Applications:

- Transient Voltage Surge Suppression
- Telephone Network Interfaces
- Modems/Cable Modems
- xDSL Modems and Peripherals
- Building Entry/Outside Plant

Features:

- UL 497B Recognized
- UL File E140906
- Non-Radioactive
- 100% Lead-Free (RoHS Compliant)
- Durable Construction
- Low Capacitance
- Proven Performance
- ISO 9001 Certified
- World Renowned Quality

Marking

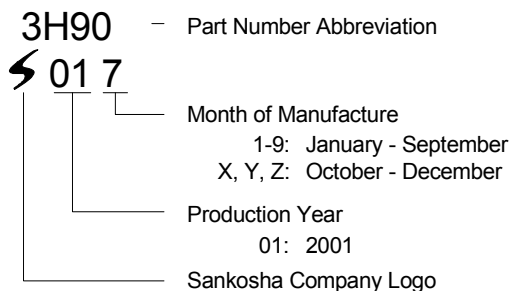

Electrical Characteristics

1.	DC Breakdown Voltage	100 V/sec	72 - 108V	(L1-E) (L2-E)		
2.	Impulse Breakdown Voltage	1 kV/μsec	< 500V	(L1-E) (L2-E)		
3.	Insulation Resistance	DC 50V	> 10,000 M-ohm			
4.	Capacitance	1 MHz	< 3.0 pF			
5.	DC Holdover Voltage	See Note	< 52V	Note: In Accordance with ITU-T K.12		
6.	Impulse Life	10/1000 μsec	200 A	> 300 times	(L1+L2-E)	
7.	Impulse Discharge Current	8/20 μsec	10 kA	Each Polarity 5 Times	(L1+L2-E)	
8.	AC Discharge Current	50 Hz	10 A	One Second	10 Times	(L1+L2-E)

After Life Tests

9.	DC Breakdown Voltage	100 V/sec	65-120V			
10.	Impulse Breakdown Voltage	1 kV/μsec	< 600V			
11.	Insulation Resistance	DC 50V	> 100 M-ohm			

SANKOSHA

SANKOSHA